

MAIN FEATURES

- Universal input voltage range (90 – 264 V_{AC})
- Active PFC, EN 61000-3-2 Class C, D compliant
- Steady 400 W output power (440 W peak)
- High efficiency (94% typical)
- Low stand by power consumption (<0.5 W)
- 12, 24, 28, 36 or 48 V_{DC} standard output voltages
- +5 V stand by, 2 A and 12 V auxiliary, 1 A outputs
- Low earth/touch leakage currents (<300/100 μA)
- Fan speed control function (Off at <50 W)
- Over temperature protection
- Input under voltage, output over voltage protections
- Over current and short circuit protection
- Remote On/Off and power good signal
- 5 available packages all fit 1U installation
- IEC/EN/UL 60950-1 and 62368-1 compliance
- EN55032, FCC Class B, conducted radiated emissions.
- EN55024 immunity
- 4000 m operation without de-rating
- RoHS 3 compliant (Directive EU 2015/863)

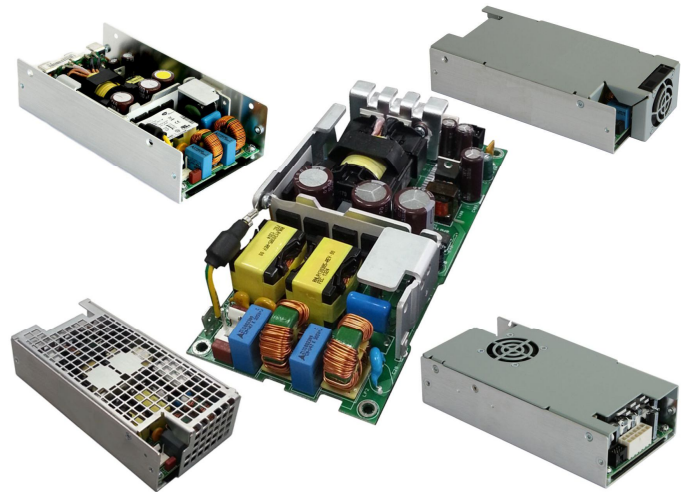

DESCRIPTION

The DDP400 series of IT rated AC-DC power supplies feature a compact form factor and a high conversion efficiency. The series provides a steady 400 W of regulated DC power through the full 90 to 264 V_{AC} input voltage range. Based on an open frame, 3.00" x 6.50" x 1.46" form factor, the series is available in five different low-profile packages to enable designers to integrate into 1U applications.

By converting energy at 94% typical efficiency, the DDP400 series generate less heat facilitating thermal management in space constrained systems and offering high reliability.

The DDP400 series is available in five standard output voltages – 12, 24, 28, 36 or 48 V_{DC} – offer an auxiliary 12 V_{DC} and 5 V_{DC} stand-by outputs. Available control signals include Power Good (P_OK), Remote On/Off (PS_ON) and remote sense compensation on the (+) load line.



Boxed and vented open frame models can deliver full output power up to 50 °C, can operate up to 70 °C with de-rating and are capable of start up from -30 °C. A built-in speed controlled fan, to ensure the required airflow while maintaining minimal operational noise, which ultimately enhances the power supply service life time.

The DDP400 range complies with the IEC/EN/UL/CSA 60950-1 and 62368-1 safety standards for Audio Video and IT equipment. It also complies with the Class B limits of the standards EN55011, EN55032 and FCC for conducted and radiated emissions, IEC/EN 61000-3 Class C for harmonic content and EN 55024 for EMC immunity.

MARKET SEGMENTS AND APPLICATIONS

- Video Wall Display & Entertainment
- Industrial and Process Control
- Telecommunications
- Test & Measurement Equipment
- Industrial Laser applications
- 3D Printing and ATM

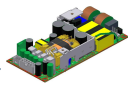
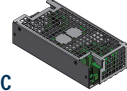
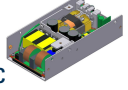
MODEL CODING AND OUTPUT RATINGS

| Model and Output Power | Output Nominal Voltage | Package Option |
|------------------------|----------------------------|--|
| ITE 400W: DDP400 | 12 V _{DC} : -US12 | Open Frame: -OF  |
| | 24 V _{DC} : -US24 | |
| | 28 V _{DC} : -US28 | Punched Cover: -PC  |
| | 36 V _{DC} : -US36 | |
| | 48 V _{DC} : -US48 | Vented Cover: -VC  Front Fan: -FF  |

MODEL CODING AND OUTPUT RATINGS

| Model Number | V1 [V] | I1 ¹ Convection [A] | I1 ² Forced air [A] | V1 ³ Ripple [mV] | V2 [V] | I2 ¹ Rated [A] | V2 ³ Ripple [mV] | 5V _{SB} [V] | I5V _{SB} ¹ Convection [A] | I5V _{SB} ² Forced air [A] | 5V _{SB} ³ Ripple [mV] |
|----------------------|-----------|--------------------------------------|--------------------------------------|-----------------------------------|-----------|---------------------------------|-----------------------------------|-------------------------|---|---|---|
| DDP400-US12-OF/UC/PC | 12 | 20.8 | 33.3 | 120 | 12 | 1 | 240 | 5 | 1.5 | 2 | 50 |
| DDP400-US24-OF/UC/PC | 24 | 10.4 | 16.7 | 240 | 12 | 1 | 240 | 5 | 1.5 | 2 | 50 |
| DDP400-US36-OF/UC/PC | 36 | 6.9 | 11.1 | 360 | 12 | 1 | 240 | 5 | 1.5 | 2 | 50 |
| DDP400-US48-OF/UC/PC | 48 | 5.2 | 8.3 | 480 | 12 | 1 | 240 | 5 | 1.5 | 2 | 50 |
| DDP400-US12-VC/FF | 12 | - | 33.3 | 120 | 12 | 1 | 240 | 5 | - | 2 | 50 |
| DDP400-US24-VC/FF | 24 | - | 16.7 | 240 | 12 | 1 | 240 | 5 | - | 2 | 50 |
| DDP400-US36-VC/FF | 36 | - | 11.1 | 360 | 12 | 1 | 240 | 5 | - | 2 | 50 |
| DDP400-US48-VC/FF | 48 | - | 8.3 | 480 | 12 | 1 | 240 | 5 | - | 2 | 50 |
| DDP400-US28-UC | 28 | 8.9 | 14.3 | 280 | 12 | 1 | 240 | 5 | 1.5 | 2 | 50 |

¹ The combined output power of V1, V2 and 5 V_{SB} for "-OF", "-UC" and "-PC" packages, must not exceed 400 W when cooled by 400 LFM air flow, and 250 W when natural convection cooled, up to 50 °C. Above 50 °C output de-rating applies. See de-rating curves below. In any case, the heat sink maximum temperature should not exceed +110 °C at 50 °C ambient temperature.

² The combined output power of V1, V2 and 5 V_{SB} for "-VC" and "-FF" packages, must not exceed 400 W up to 50 °C, and 280 W at 70 °C ambient temperature. See de-rating curves below.

³ Peak-to-Peak measured at 20 MHz Bandwidth.

INPUT SPECIFICATIONS

| Specification | Test Conditions / Notes | Min. | Nominal | Max. | Units |
|--------------------------|--|------|----------------------|------------|-----------------|
| AC Input Voltage | PS starts and operates at 90 V _{AC} at all load conditions | 90 | 100-240 | 264 | V _{AC} |
| DC Input Voltage | | 170 | - | 270 | V _{DC} |
| Input Frequency | | 47 | 50/60 | 440 | Hz |
| Input Current | RMS at 180 V _{AC} , maximum load RMS at 90 V _{AC} , maximum load | - | - | 2.5 5 | A |
| Inrush Current (peak) | 265 V _{AC} , 25 °C ambient, cold start. 24, 28, 36, 48 V _{DC} , no damage 12 V _{DC} | - | - | - 20 | A |
| Fusing | 2x Time Lag 6.3 A, 250 V on both L and N | - | - | 6.3 | A |
| Efficiency | At 230 V _{AC} : 20% rated load 50 – 100 % rated load At 115 V _{AC} : 20% rated load 50 – 100 % rated load | - | 90 94 90 92 | - | % |
| Input Power Consumption | Power on, 115-230 V _{RMS} , no load Stand by, 115-230 V _{RMS} , no load | - | 1 0.4 | 1.5 0.5 | W |
| Power Factor | At full rated load, 115 V _{AC} , 60 Hz and 230 V _{AC} , 50 Hz input voltages | 0.95 | - | - | - |
| Harmonic Current | Complies with EN-61000-3-2 Class C at 230 V _{AC} 50 Hz, load >50 W. | | | | |
| Fluctuations and Flicker | Complies with EN-61000-3-3 at nominal voltages and full load. | | | | |
| Earth Leakage Current | Normal conditions, 240 V _{RMS} , 60 Hz. | - | - | 300 | µA |

OUTPUT SPECIFICATIONS

| Specification | Test Conditions / Notes | Min. | Nom. | Max. | Units |
|---|--|-------|------|-----------|--------------------------|
| V1 Output Voltage | 0.5% set point accuracy for all voltage variants | - | 12 | - | V |
| | | - | 24 | - | |
| | | - | 28 | - | |
| | | - | 36 | - | |
| | | - | 48 | - | |
| V1 Output Power Rating | All voltages, OF/UC/PC, convection cooling | - | - | 250 | W |
| | All voltages, VC/FF, and OF/UC/PC forced air cooling (> 400 LFM) | - | - | 400 | |
| | All models, peak power (≤ 10 s) | - | - | 440 | |
| V2 Output Voltage (*) | All models. Load on V2: from 5 to 1000 mA Load on V1: from 0.1 to I1 rated | 11.35 | 11.5 | 12.65 | V |
| V2 Output Current (I2) | Convection / forced air cooling | - | - | 1 | A |
| 5V_{SB} Output Voltage | 3% set point accuracy | - | 5 | - | V |
| 5V_{SB} Output Current (I5V_{SB}) | OF/UC/PC, natural convection cooling | - | - | 1.5 | A |
| | VC/FF, OF/UC/PC forced air cooling (> 400 LFM) | - | - | 2 | |
| V1 Voltage Adjustment Range | | - | - | ± 5 | %V1 |
| V1 Load-Line-Cross Regulation | V _{AC} : 90 – 264 V _{RMS} | - | - | ± 2 | %V1 |
| | V1 Load: 0 – 33.3 A (12 V _{DC}) | | | | |
| | 0 – 16.7 A (24 V _{DC}) | | | | |
| | 0 – 14.3 A (28 V _{DC}) | | | | |
| | 0 – 13.9 A (36 V _{DC}) | | | | |
| | 0 – 8.3 A (48 V _{DC}) | | | | |
| V2 Load: 0 – 1 A | | | | | |
| 5 V _{SB} Load: 0 – 2 A | | | | | |
| 5V_{SB} Load-Line-Cross regulation | V _{AC} : 90 – 264 V _{RMS} | - | - | ± 5 | %5V _{SB} |
| | V1 Load: 0 – 33.3 A (12V) | | | | |
| | 0 – 16.7 A (24V) | | | | |
| | 0 – 14.3 A (28V) | | | | |
| | 0 – 13.9 A (36V) | | | | |
| | 0 – 8.3 A (48V) | | | | |
| V2 Load: 0 – 1 A | | | | | |
| 5 V _{SB} Load: 0 – 2 A | | | | | |
| V1 Line Regulation | V _{AC} : 90 – 264 V _{RMS} | - | - | ± 0.1 | %V1 |
| Transient Response (Voltage Deviation) V1, 5V_{SB} | 25 % load changes at 1 A/ μ s | - | - | ± 5 | %V1 %5V _{SB} |
| | 12 V _{DC} at 2200 μ F Load / I _{OUT} > 0.5 A | | | | |
| | 24 V _{DC} at 1000 μ F Load / I _{OUT} > 0.5 A | | | | |
| | 28 V _{DC} at 1000 μ F Load / I _{OUT} > 0.5 A | | | | |
| | 36 V _{DC} at 820 μ F Load / I _{OUT} > 0.5 A | | | | |
| | 48 V _{DC} at 560 μ F Load / I _{OUT} > 0.5 A | | | | |
| 5 V _{SB} at 560 μ F Load / I _{OUT} > 0.1 A | | | | | |
| V1 Ripple and Noise | All models, Peak-to-peak, 20 MHz BW. 100 nF ceramic and 10 μ F tantalum caps at the load. | - | - | 1 | %V1 |
| Start-up Rise Time | 90 < V _{IN} < 264, any load conditions. | 5 | - | 85 | ms |
| Start-up Delay | V1 in regulation after PS_ON is asserted | - | - | 200 | ms |
| | V1 in regulation after AC is applied | - | - | 750 | |
| | 5V _{SB} in regulation after AC is applied | - | - | 500 | |
| Turn-on Overshoot | At I1 = 500 mA, V1 in regulation within 50 ms. | - | 10 | - | %V1 |
| | | - | 10 | - | %V2 |
| | | - | 10 | - | %V _{SB} |
| Hold-up Time | At nominal V _{IN} , 400 W, for all models | - | 16 | - | ms |
| | At nominal V _{IN} , 365 W, for all models | - | 20 | - | |
| | At nominal V _{IN} , 200 W, for all models | - | 35 | - | |
| Minimum Load (*) | All models; V1, V2 and 5V _{SB} | 0 | - | - | A |
| Maximum Load Capacitance | At nominal V _{IN} , 25 °C ambient | - | - | 33.000 | μ F |
| | 12 V _{DC} | - | - | 16.000 | |
| | 24 V _{DC} | - | - | 14.300 | |
| | 28 V _{DC} | - | - | 10.000 | |
| | 36 V _{DC} | - | - | 7.000 | |
| 48 V _{DC} | - | - | - | | |
| Temperature Drift | | -1.2 | - | +1.2 | mV/°C |

(*) when the load on the main output is less than 100 mA, V2 output voltage might regulate below its minimum value. Contact ENEDO for details.

SIGNALS / CONTROLS

| Signal | Notes | Min | Typ | Max | Unit |
|-------------------------|---|------|-----|-----|------|
| PS_ON | Active low, +5 V TTL signal compatible. Input low voltage | 0 | - | 2.0 | V |
| | Input high voltage ($I_{IN} = 200 \mu A$) | 3.0 | - | - | V |
| | V1 and V2 disabled when PS_ON is open | | | | |
| P_OK | 5 V _{SB} not affected by PS_ON | | | | |
| | V1 and V2 enabled with PS_ON connected to RTN | | | | |
| P_OK | +5 V TTL compatible | | | | |
| | Logic level low (<10 mA sinking) | - | - | 0.7 | V |
| | Logic level high (100 μA sourcing) | 2.4 | - | 5 | V |
| | Low to high time after V1 in regulation | 0.05 | - | 0.1 | s |
| | Power down warning time | 1 | - | - | ms |
| 5V _{SB} output | Active and in regulation after a $90 < V_{AC} < 264$ is applied | - | - | 200 | ms |
| | 5 V _{SB} not affected by PS_ON | | | | |

SIGNALS TIMING

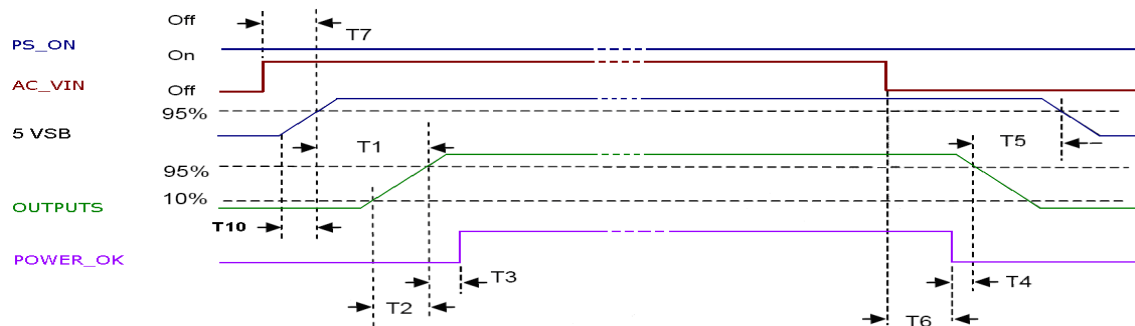

Above waveforms are expected with AC Input ON/OFF:

| | |
|--|---|
| Standby on - Main outputs on | $50 \text{ ms} \leq T1 \leq 250 \text{ ms}$ |
| Main output Rise Time | $5 \text{ ms} \leq T2 \leq 85 \text{ ms}$ |
| 5 VSB Rise Time | $4 \text{ ms} \leq T10 \leq 20 \text{ ms}$ |
| Main outputs On - P_OK delay | $40 \text{ ms} \leq T3 \leq 100 \text{ ms}$ |
| Power down warning ¹ | $T4 \geq 1 \text{ ms}$ |
| Main Output off - Standby off ² | $T5 \geq 1.2 \text{ s}$ |
| Hold-up time (AC off - P_OK low) | $T6 \geq 15 \text{ ms} (115/230 V_{AC})$ |
| AC_ON - Standby turn on time | $T7 \leq 500 \text{ ms}$ |

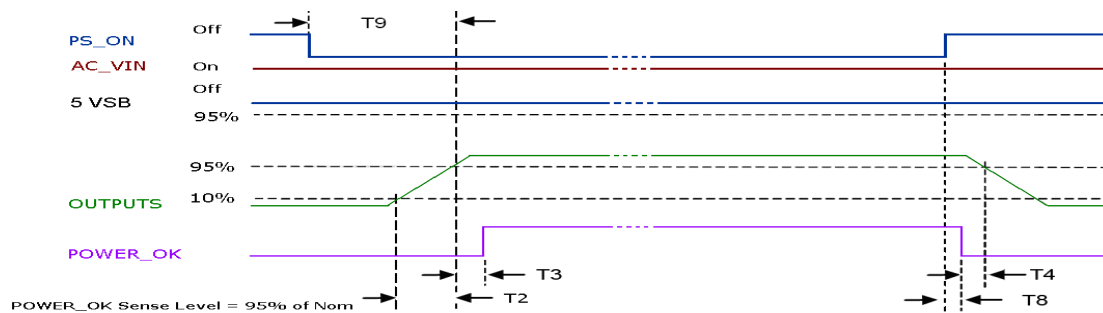

Above waveforms are expected with PS_ON Signal ON/OFF state change:

| | |
|----------------------------------|---|
| Main Output Rise Time | $5 \text{ ms} \leq T2 \leq 85 \text{ ms}$ |
| Main Outputs on - P_OK delay | $50 \text{ ms} \leq T3 \leq 100 \text{ ms}$ |
| Power down warning ¹ | $1 \text{ ms} \leq T4 \leq 5 \text{ ms}$ |
| PS_ON - Main Output (off) Timing | $T8 \leq 1 \text{ ms}$ |
| PS_ON - Main Output (on) Timing | $T9 \leq 200 \text{ ms}$ |

¹ T4 parameter measurement setup will assume at least 10% of the maximum load on each output.

² T5 parameter measurement setup will assume at least 50% of the maximum load on main output.

PROTECTION FEATURES

| Specification | Test Conditions / Notes | Min. | Nominal | Max. | Units |
|---|--|------|---------|------|-------------------|
| Input Under Voltage Lockout | Auto recovery, Hiccup Mode | 60 | 75 | - | V _{AC} |
| Input Fuse | 2x Time Lag 6.3 A, 250 V on L1 and L2 | - | - | 6.3 | A |
| Over Current | At nominal input voltages. V1: Hiccup mode, auto-recovering. V2: PTC limiting, auto-recovering. 5 V _{SB} : Hiccup mode, auto-recovering. | 110 | - | 150 | %I _{MAX} |
| Short Circuit | At nominal input voltages. V1: Hiccup mode, auto-recovering. V2: PTC limiting, auto-recovering 5 V _{SB} : Hiccup mode, auto-recovering. | - | - | - | |
| Over Voltage | 12 V _{DC} 24 V _{DC} 28 V _{DC} 36 V _{DC} 48 V _{DC} 5 V _{SB} | 110 | - | 136 | %V _{NOM} |
| Over Temperature (on primary stage) | Unit shut down and latch off Shut down, latch off. | - | - | - | |
| Over Temperature (on secondary side) | Hiccup mode, auto-recovering. | - | - | - | |
| Isolation Primary-to-Secondary | Reinforced | 4000 | - | - | V _{AC} |
| Isolation Input-to-PE | Basic | 1500 | - | - | V _{AC} |
| Isolation V1-to-V2 | | 100 | - | - | V _{DC} |
| Isolation Output-to-PE | Basic | 1500 | - | - | V _{AC} |

ENVIRONMENTAL SPECIFICATIONS

| Specification | Test Conditions / Notes | Min | Nominal | Max | Units |
|---|--|---------|---------|----------|--------|
| Operating Temperature Range | No de-rating up to 50 °C PS starts up at -30 °C | -20 | - | 50 | °C |
| De-rated Operating Temperature Range | Natural convection cooling: Linearly de-rate from 250W at 50 °C, to 100 W at 70 °C Forced air cooling: Linearly de-rate from 400 W at 50 °C, to 280 W at 70 °C. See graphs below. | - | - | 70 | °C |
| Storage Temperature Range | | -40 | - | 85 | °C |
| Humidity | RH, Non-condensing Operating Non-operating | - | - | 90 95 | % % |
| Operating Altitude | | - | - | 4000 | m |
| Shock | EN 60068-2-27 Operating: Half sine, 30 g, 18 ms, 3 axes, 6x each (3 positive and 3 negative). Non-Operating: Half sine, 50 g, 11 ms, 3 axes, 6x each (3 positive and 3 negative). | | | | |
| Vibration | EN 60068-2-64 Operating: Sine, 10 – 500 Hz, 1 g, 3 axes, 1 oct/min., 60 min. Random, 5 – 500 Hz, 0.02 g ² /Hz, 1 g _{RMS} , 3 axes, 30 min. Non-Operating: 5 – 500 Hz, 2.46 g _{RMS} (0.0122 g ² /Hz), 3 axes, 30 min. | | | | |
| MTBF | Full Load, 120 V _{AC} , 40 °C ambient 80 % Duty cycle, Telcordia SR-332 Issue 2 | 400.000 | - | - | Hours |
| Useful Life | Low line range, 200 W, 40 °C ambient, natural convention. | - | 4 | - | Years |
| Thermal Considerations | The output power de-rating curves are herein provided. These curves can be used as a guideline to assess the limit in performance of a power supply once installed in a system providing controlled air flow at a certain input voltage and ambient temperature. | | | | |

OUTLINE DRAWING AND CONNECTIONS – OPEN FRAME (OF)

| Connector | Manufacturer and Part Number |
|--------------------------------------|---|
| AC Input Connector P1 | Molex 26-60-4030 or equivalent |
| P1 Mating Connector | Molex 09-93-0300 (Crimp Terminal Housing) Molex 08-50-0105 (Crimp Terminal, 18-24 AWG) |
| Protection Earth Connector P5 | Tyco 63849-1 equivalent |
| P5 Mating Connector | Any tin finished 6.35x0.81 mm receptacle |
| Output Connector P4 | Molex 39-28-8120 or equivalent |
| P4 Mating Connector | Molex 39-01-2120 (Crimp Terminal Housing) Molex 39-00-0039 (Crimp Terminal, 18-24 AWG) |
| Signals Connector P6 | Molex 90130-1108 or equivalent |
| P6 Mating Connector | Molex 90142-0008 (Crimp Terminal Housing) Molex 90119-0109 (Crimp Terminal, 22-24 AWG) |

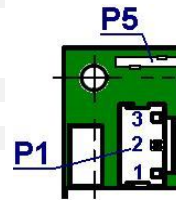

| AC Input P1 | |
|-------------|-------------|
| Pin | Function |
| 1 | Line 1 |
| 2 | Not Present |
| 3 | Line 2 |

| Protection Earth P5 | |
|---------------------|-----------|
| Pin | Function |
| GND | AC Ground |

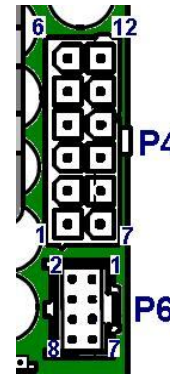

| Output Connector P4 | |
|---------------------|-----------|
| Pin | Function |
| 1-6 | V1 |
| 7-12 | DC Return |

| Signal Connector P6 | |
|---------------------|-------------------|
| Pin | Function |
| 1 | +5V _{SB} |
| 2 | P_OK |
| 3 | -V2 |
| 4 | PS_ON |
| 5 | RS+ |
| 6 | RTN |
| 7 | +V2 |
| 8 | RTN |

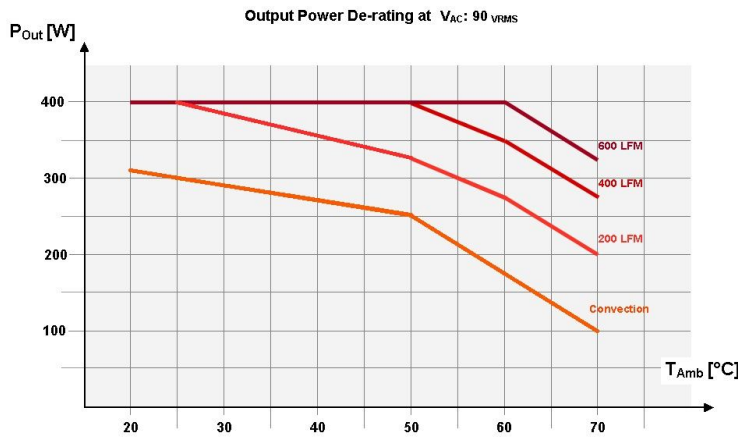

Overall dimensions: 76.0 x 164.2 x 37.7 mm (2.99 x 6.46 x 1.48 in)

Weight: 410 g (0.90 lb)

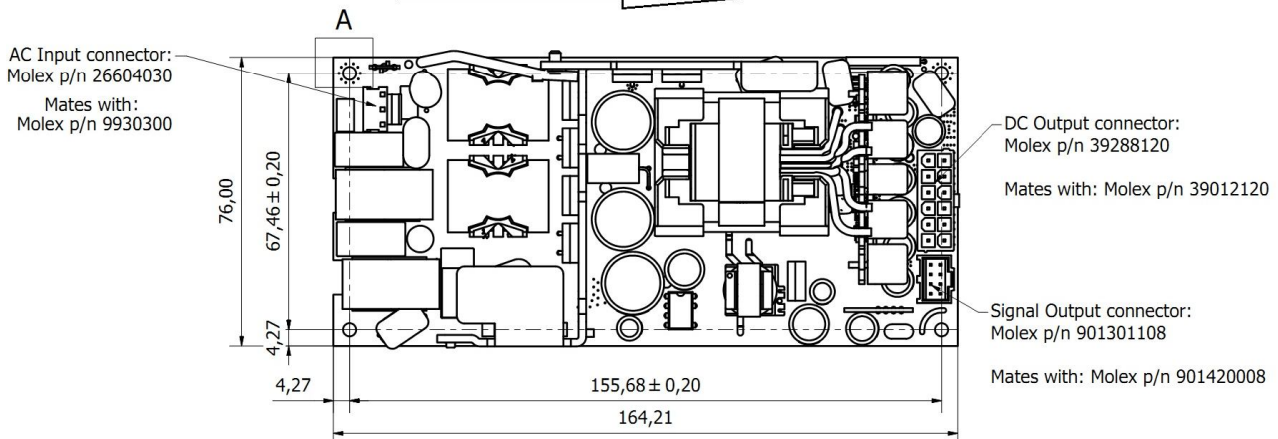
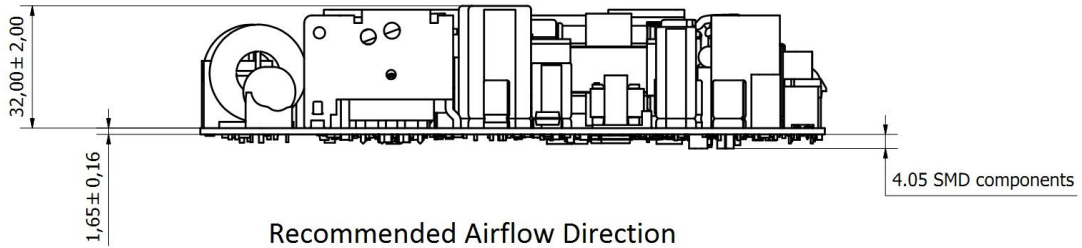

OUTLINE DRAWING AND CONNECTIONS – U-CHASSIS (UC)

| Connector | Manufacturer and Part Number |
|--------------------------------------|---|
| AC Input Connector P1 | Molex 26-60-4030 or equivalent |
| P1 Mating Connector | Molex 09-93-0300 (Crimp Terminal Housing) Molex 08-50-0105 (Crimp Terminal, 18-24 AWG) |
| Protection Earth Connector P5 | Tyco 63849-1 equivalent |
| P5 Mating Connector | Any tin finished 6.35x0.81 mm receptacle |
| Output Connector P4 | Molex 39-28-8120 or equivalent |
| P4 Mating Connector | Molex 39-01-2120 (Crimp Terminal Housing) Molex 39-00-0039 (Crimp Terminal, 18-24 AWG) |
| Signals Connector P6 | Molex 90130-1108 or equivalent |
| P6 Mating Connector | Molex 90142-0008 (Crimp Terminal Housing) Molex 90119-0109 (Crimp Terminal, 22-24 AWG) |

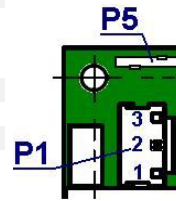

| AC Input P1 | |
|-------------|-------------|
| Pin | Function |
| 1 | Line 1 |
| 2 | Not Present |
| 3 | Line 2 |

| Protection Earth P5 | |
|---------------------|-----------|
| Pin | Function |
| GND | AC Ground |

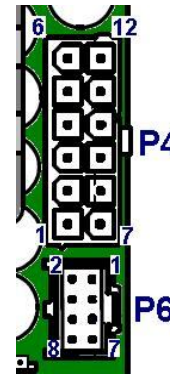

| Output Connector P4 | |
|---------------------|-----------|
| Pin | Function |
| 1-6 | V1 |
| 7-12 | DC Return |

| Signal Connector P6 | |
|---------------------|-------------------|
| Pin | Function |
| 1 | +5V _{SB} |
| 2 | P_OK |
| 3 | -V2 |
| 4 | PS_ON |
| 5 | RS+ |
| 6 | RTN |
| 7 | +V2 |
| 8 | RTN |

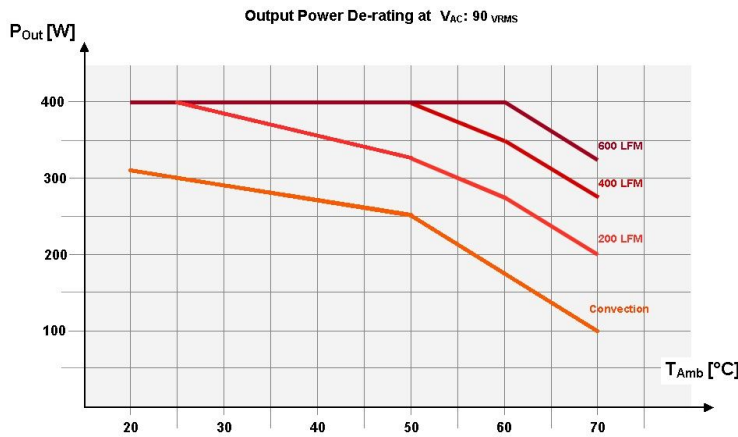

Overall dimensions: 84.4 x 166.5 x 40.0 mm (3.32 x 6.55 x 1.57 in)

Weight: 525 g (1.16 lb)

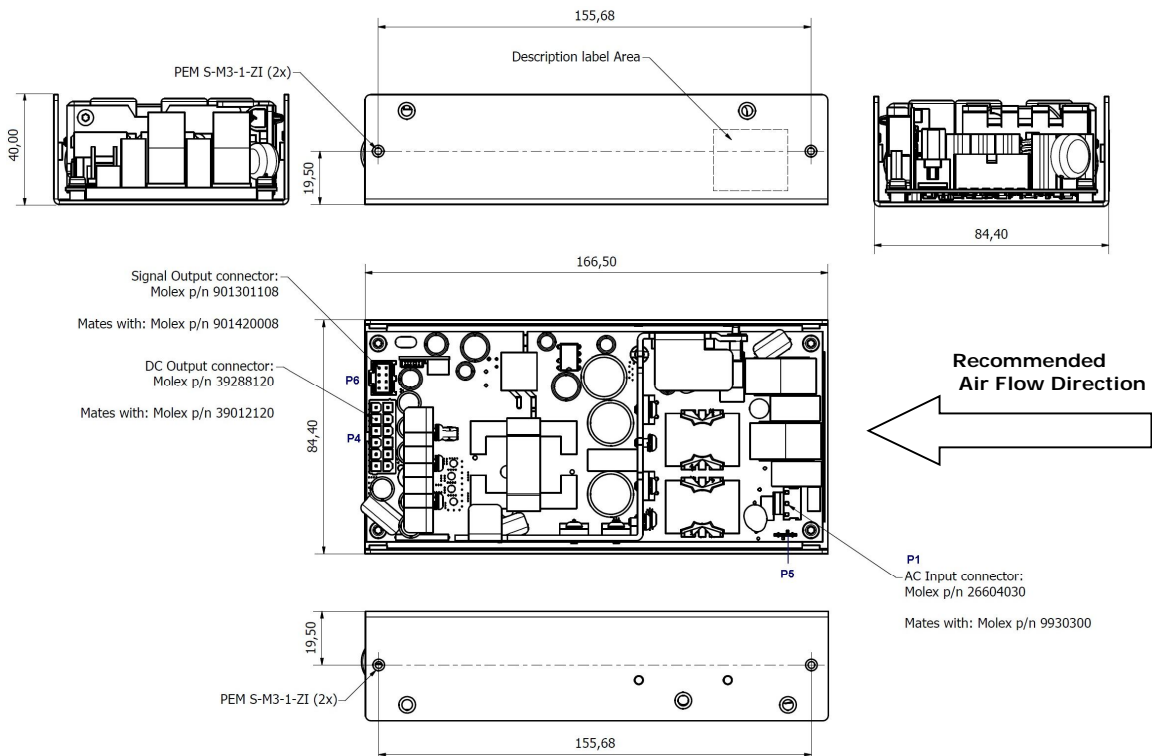

OUTLINE DRAWING AND CONNECTIONS – PUNCHED COVER (PC)

| Connector | Manufacturer and Part Number |
|--------------------------------------|---|
| AC Input Connector P1 | Molex 26-60-4030 or equivalent |
| P1 Mating Connector | Molex 09-93-0300 (Crimp Terminal Housing) Molex 08-50-0105 (Crimp Terminal, 18-24 AWG) |
| Protection Earth Connector P5 | Tyco 63849-1 equivalent |
| P5 Mating Connector | Any tin finished 6.35x0.81 mm receptacle |
| Output Connector P4 | Molex 39-28-8120 or equivalent |
| P4 Mating Connector | Molex 39-01-2120 (Crimp Terminal Housing) Molex 39-00-0039 (Crimp Terminal, 18-24 AWG) |
| Signals Connector P6 | Molex 90130-1108 or equivalent |
| P6 Mating Connector | Molex 90142-0008 (Crimp Terminal Housing) Molex 90119-0109 (Crimp Terminal, 22-24 AWG) |

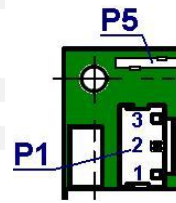

| AC Input P1 | |
|-------------|-------------|
| Pin | Function |
| 1 | Line 1 |
| 2 | Not Present |
| 3 | Line 2 |

| Protection Earth P5 | |
|---------------------|-----------|
| GND | AC Ground |
| | |

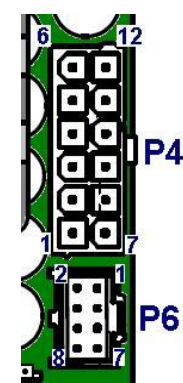

| Output Connector P4 | |
|---------------------|-----------|
| Pin | Function |
| 1-6 | V1 |
| 7-12 | DC Return |

| Signal Connector P6 | |
|---------------------|-------------------|
| Pin | Function |
| 1 | +5V _{sb} |
| 2 | P_OK |
| 3 | -V2 |
| 4 | PS_ON |
| 5 | RS+ |
| 6 | RTN |
| 7 | +V2 |
| 8 | RTN |

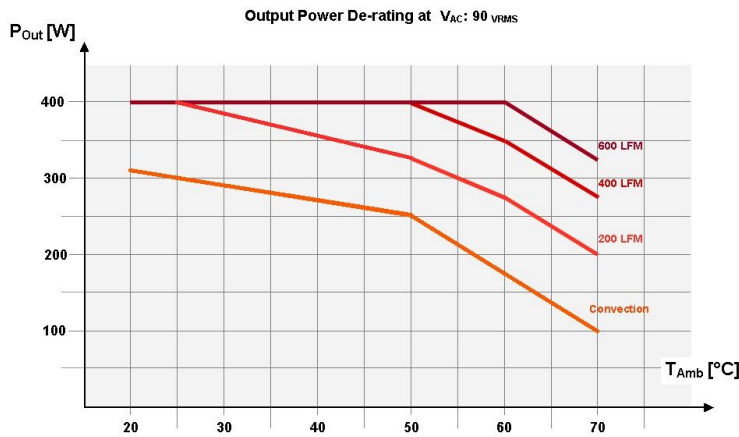

Overall dimensions: 84.4 x 170.5 x 41.0 mm (3.32 x 6.71 x 1.61 in)

Weight: 575 g (1.43 lb)

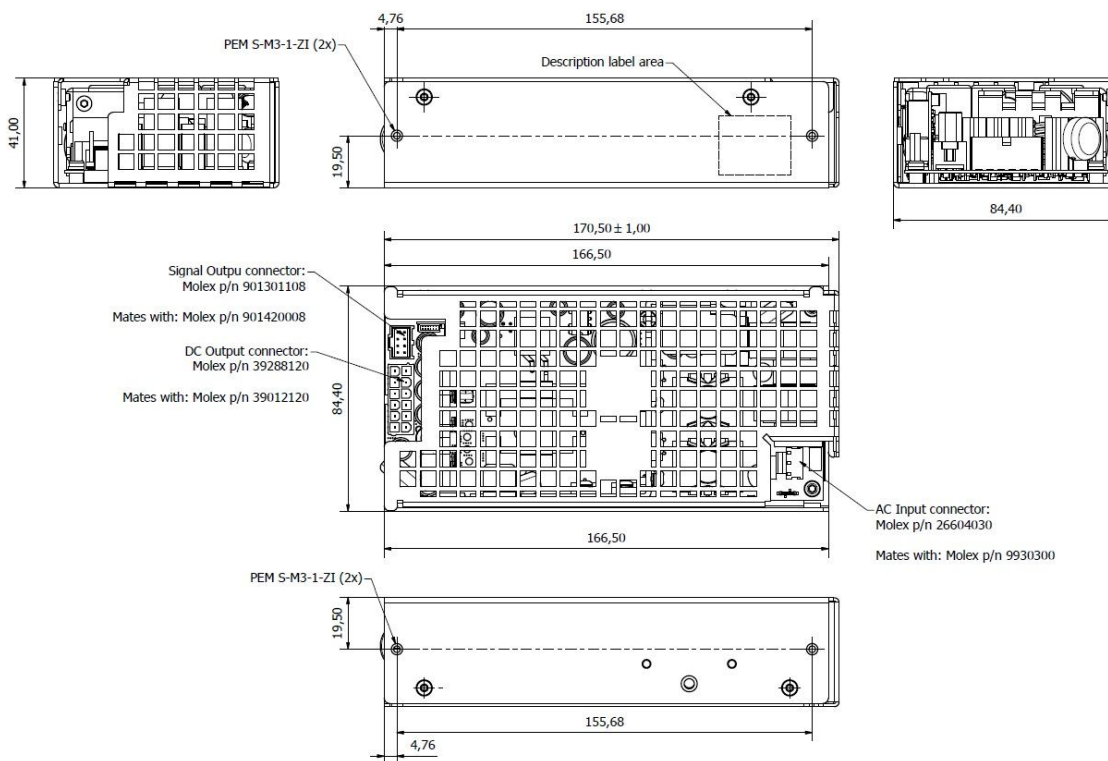

OUTLINE DRAWING AND CONNECTIONS – VENTED COVER (VC)

| Connector | Manufacturer and Part Number |
|--------------------------------------|---|
| AC Input Connector P1 | Molex 26-60-4030 or equivalent |
| P1 Mating Connector | Molex 09-93-0300 (Crimp Terminal Housing) Molex 08-50-0105 (Crimp Terminal, 18-24 AWG) |
| Protection Earth Connector P5 | Tyco 63849-1 equivalent |
| P5 Mating Connector | Any tin finished 6.35x0.81 mm receptacle |
| Output Connector P4 | Molex 39-28-8120 or equivalent |
| P4 Mating Connector | Molex 39-01-2120 (Crimp Terminal Housing) Molex 39-00-0039 (Crimp Terminal, 18-24 AWG) |
| Signals Connector P6 | Molex 90130-1108 or equivalent |
| P6 Mating Connector | Molex 90142-0008 (Crimp Terminal Housing) Molex 90119-0109 (Crimp Terminal, 22-24 AWG) |

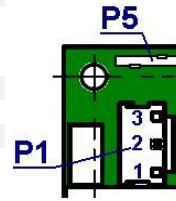

| AC Input P1 | |
|-------------|-------------|
| Pin | Function |
| 1 | Line 1 |
| 2 | Not Present |
| 3 | Line 2 |

| Protection Earth P5 | |
|---------------------|-----------|
| Pin | Function |
| GND | AC Ground |

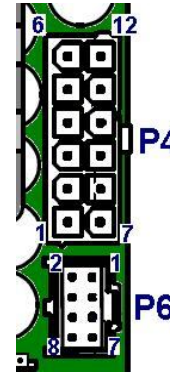

| Output Connector P4 | |
|---------------------|-----------|
| Pin | Function |
| 1-6 | V1 |
| 7-12 | DC Return |

| Signal Connector P6 | |
|---------------------|-------------------|
| Pin | Function |
| 1 | +5V _{SB} |
| 2 | P_OK |
| 3 | -V2 |
| 4 | PS_ON |
| 5 | RS+ |
| 6 | RTN |
| 7 | +V2 |
| 8 | RTN |

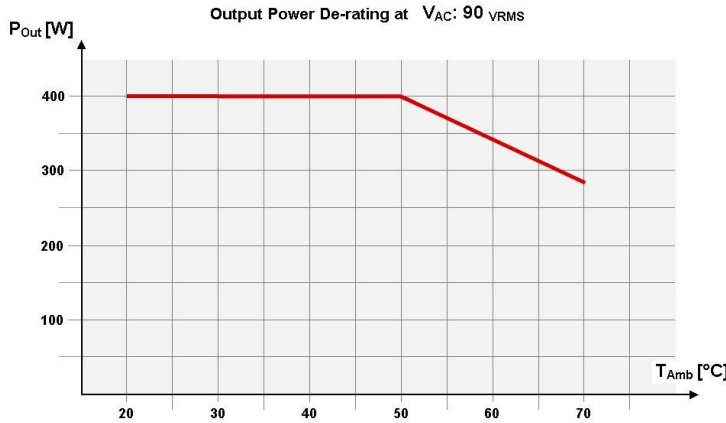

Overall dimensions: 84.4 x 166.5 x 41.0 mm (3.32 x 6.55 x 1.61 in)

Weight: 670 g (1.48 lb)

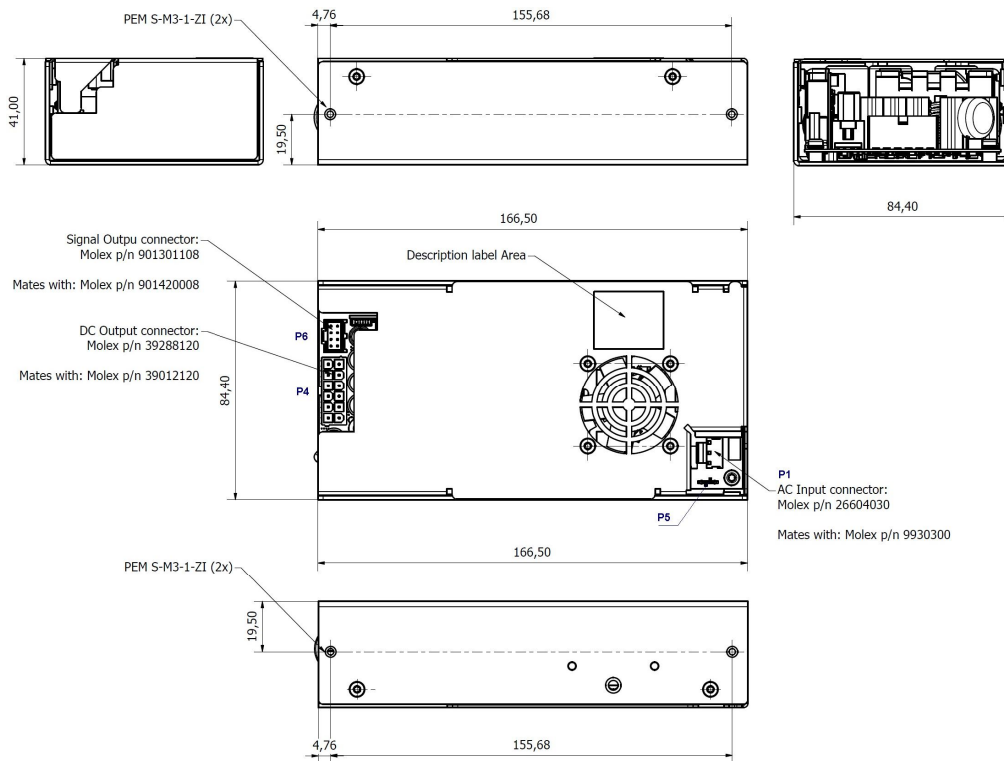

OUTLINE DRAWING AND CONNECTIONS – FRONT FAN (FF)

| Connector | Manufacturer and Part Number |
|--------------------------------------|---|
| AC Input Connector P1 | Molex 26-60-4030 or equivalent |
| P1 Mating Connector | Molex 09-93-0300 (Crimp Terminal Housing) Molex 08-50-0105 (Crimp Terminal, 18-24 AWG) |
| Protection Earth Connector P5 | Tyco 63849-1 equivalent |
| P5 Mating Connector | Any tin finished 6.35x0.81 mm receptacle |
| Output Connector P4 | Molex 39-28-8120 or equivalent |
| P4 Mating Connector | Molex 39-01-2120 (Crimp Terminal Housing) Molex 39-00-0039 (Crimp Terminal, 18-24 AWG) |
| Signals Connector P6 | Molex 90130-1108 or equivalent |
| P6 Mating Connector | Molex 90142-0008 (Crimp Terminal Housing) Molex 90119-0109 (Crimp Terminal, 22-24 AWG) |

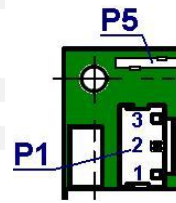

| AC Input P1 | |
|-------------|-------------|
| Pin | Function |
| 1 | Line 1 |
| 2 | Not Present |
| 3 | Line 2 |

| Protection Heart P5 | |
|---------------------|-----------|
| Pin | Function |
| GND | AC Ground |

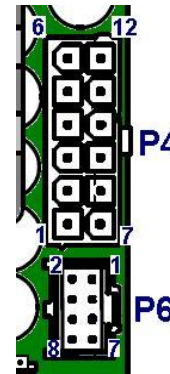

| Output Connector P4 | |
|---------------------|-----------|
| Pin | Function |
| 1-6 | V1 |
| 7-12 | DC Return |

| Signal Connector P6 | |
|---------------------|-------------------|
| Pin | Function |
| 1 | +5V _{SB} |
| 2 | P_OK |
| 3 | -V2 |
| 4 | PS_ON |
| 5 | RS+ |
| 6 | RTN |
| 7 | +V2 |
| 8 | RTN |

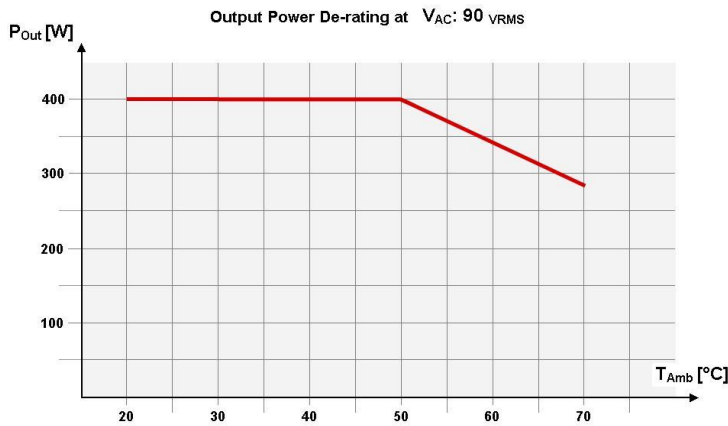

Overall dimensions: 84.4 x 183.0 x 41.0 mm (3.32 x 7.20 x 1.61 in)

Weight: 685 g (1.51 lb)

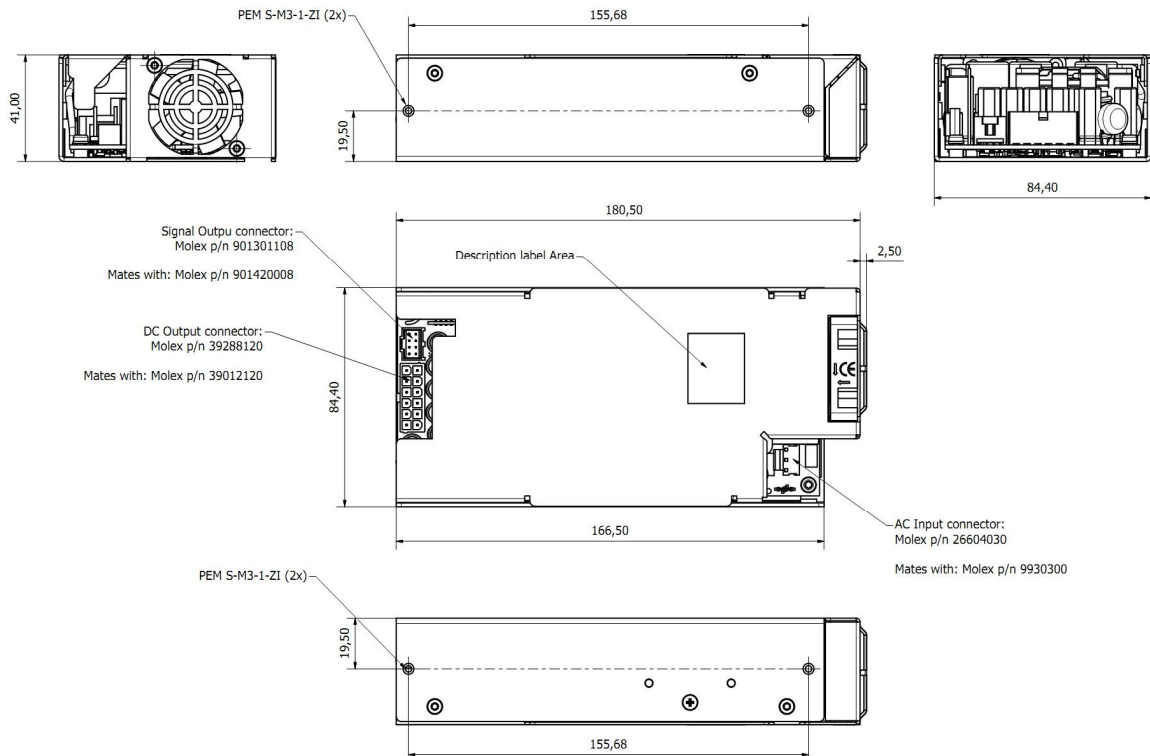

ELECTROMAGNETIC COMPATIBILITY (EMC) – EMISSIONS

| Phenomenon | Conditions / Notes | Standard | Equipment Performance Class |
|---|---|----------------|-----------------------------|
| Conducted | 115 V _{RMS} , 230 V _{RMS} . Maximum load 4 dB minimum margin | EN 55032 (ITE) | B |
| Radiated | At 10 m distance | EN 55032 (ITE) | B |
| Line Voltage Fluctuation and Flicker | At 20 %, 50 % and 100 % maximum load Nominal input voltages | EN 61000-3-3 | |
| Harmonic Current Emission | Nominal input voltages Output load > 50 W | EN 61000-3-2 | C |

ELECTROMAGNETIC COMPATIBILITY (EMC) – IMMUNITY

| Phenomenon | Conditions / Notes | Standard | Test Level | Performance criteria |
|--|---|--|------------|----------------------|
| Reference standard for IT equipment: EN 55024 | | | | |
| ESD | 15 kV air discharge, 8 kV contact, at any point of the system. | EN 61000-4-2 | 4 | A |
| Radiated Field | 3 V/m, 80-1000 MHz, 1 KHz 80% AM. Dwell time is 3 sec for 2 Hz modulation Dwell time is 1 sec for 1KHz modulation | EN 61000-4-3 | 3 | A |
| Electric Fast Transient | ±2 kV on AC power port for 1 minute; ±1 kV on signal/control lines | EN 61000-4-4 | 3 | A |
| Surge | ± 2 kV line to line; ± 4 kV line to earth; on AC power port. | EN 61000-4-5 | 3 | A B |
| Conducted RF Immunity | 3 V _{RMS} , 0,15-80 MHz, 1 KHz/2 Hz 80% AM 100 - 240V _{AC} | EN 61000-4-6 | 3 | A |
| Dips and Interruptions | Drop-out to 5% for 0.5 cycles (10 ms) Dip to 70% for 25 cycles (500 ms) Interrupts > 95% for 5 s | EN61000-4-11 EN61000-4-11 EN61000-4-11 | | A B B |

SAFETY AGENCIES APPROVALS

| Certification Body | Safety Standards and file numbers | Category |
|---------------------------------------|---|--|
| CSA/UL | CSA C22.2 No. 60950-1, UL 60950-1 and UL 62368-1 | Audio Video and Information Technology Equipment |
| IEC IECCE CB Certification | IEC/EN 60950-1 and IEC/EN 62368-1 | Audio Video and Information Technology Equipment |
| CE | Directive 2014/35/EU: Electrical Safety: Low Voltage electrical equipment (LVD) Directive 2014/30/EU: Electromagnetic Compatibility (EMC) Directive EU 2015/863: RoHS 3 | Audio Video and Information Technology Equipment |

Specifications appearing in ENEDO's catalogues and brochures as well as any oral statements are not binding. All descriptions, drawings and other particulars (including dimensions, materials and performance data) given by ENEDO are as accurate as possible but, being given for general information, and are not binding on ENEDO. ENEDO makes thus no representation or warranty as to the accuracy of such material. We assume no liability other than as agreed in the terms of the individual contracts and we reserve the right to make technical modifications in the course of our product development. Our product information solely describes our goods and services and is in no way to be construed or interpreted as a quality or condition guarantee. The aforesaid shall not relieve the customer of its obligation to verify the suitability of our Products for the use or application intended by the purchaser. Customers are responsible for their products and applications. ENEDO assumes no liability from the use of its products outside of specifications. No license is granted to any intellectual property rights by this document.